

Technical data and measuring conditions

- Rated current: 16~150A@50°C
- Max. continuous operating voltage: 3x600 / 347VAC
- Operating frequency: dc to 60Hz
- Operating temp. : -25°~ + 100° (25/100/21)
- Hi-pot. test voltage (for 2 sec.):
P/N - E: 2000 VDC
P to P: 1900 VDC
P to N: 1100 VDC
- Protection category: IP20
- Flammability corresponding to: UL 94V-2 or better
- MTBF@50°C/400V(Mill-HB-217F): 410,000 hours
- Design corresponding to: UL1283, UL60939, CSA 22.2 No.8-13, IEC/EN60939
- Overload capability: 4 x rated current at switch on; 1.5 x rated current for 1 min., once per hour

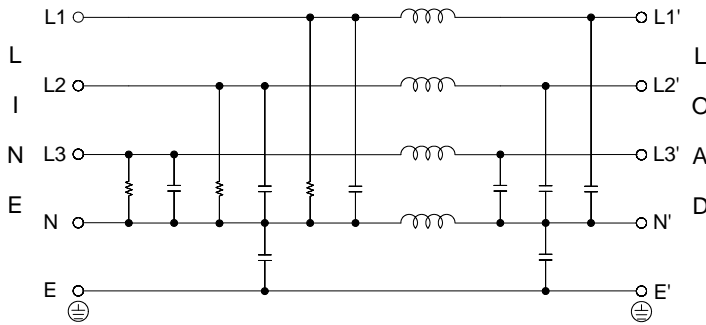

Electrical schematic



Marketing applications

- Three-phase four-wire networks
- Medical device (not body-coupled)
- Industrial electric appliances
- High power office equipment
- Power management system

Features

- Superior conducted attenuation performance
- Current rating 16~150A
- Low leakage current values
- Compact and lightweight design
- Metal chassis mounted
- Touch-safe connections with hinged safety covers

Filter selection table

Filter PRJ No.	Rated Current @50°C [A]	Typical Drive* Power Rating [kW]	Leakage Current** @600VAC/50Hz [mA]	Power Loss @25°C/50Hz [W]
16SC56	16	7.5	0.1	7
25SC56	25	10	0.1	10.1
36SC56	36	15	0.1	10.9
50SC56	50	19	0.1	15.8
100SC56	100	22	0.1	24
100SC56S	100	22	0.1	24
150SC56S	150	30	0.1	45.9

*Calculated at rated current, 600 VAC and cos phi = 0.8. The exact value depends upon the efficiency of the drive, the motor and the entire application.

**Standardized calculated leakage current acc. IEC60939 under normal operating conditions.

Filter attenuation Insertion loss (dB) in 50Ω system CISPR 17

Common mode / Asymmetrical (P-E)

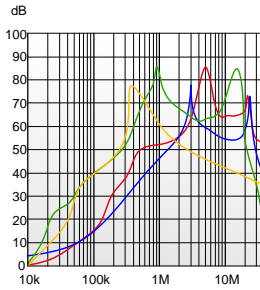

Differential mode / Symmetrical (P-P)

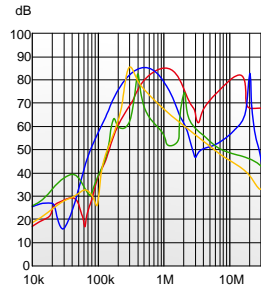

- 16A ————
- 25~50A ————
- 100A ————
- 150A ————

Mechanical drawing

■ 16~100A

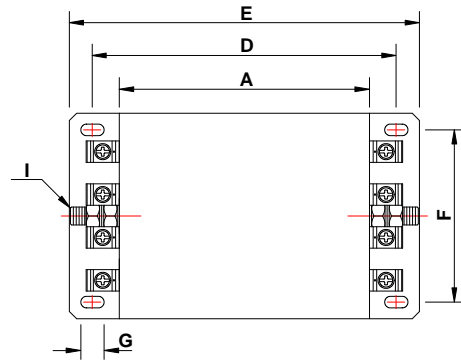
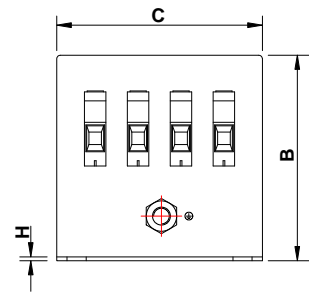

■ 100~150A

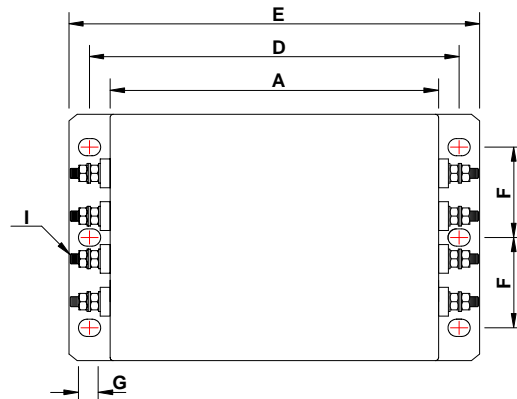
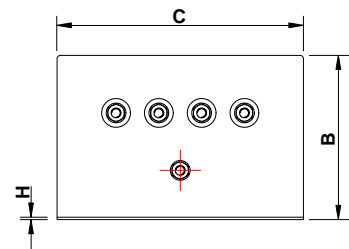

Dimensions (unit: mm) Tolerances according to ISO 2768-m / EN 22768-m

Code	16~36A	50A	100A	150A
A	140	142.5	210	300
B	80	102	130	130
C	105	122	160	160
D	165.5	168	230	320
E	189	192	250	340
F	80	98	65	60
G	13x6.5	13x6.5	13x6.5	13x6.5
H	1	1	1	1
I	M6	M6	M10	M10